



Project: _____
Customer: _____
Engineer: _____
Pump Manufacturer: _____

Technical Data Submittal Document

Model GPL Limited Service Full Voltage Across the Line Start Electric Fire Pump Controller



Contents:

- Data Sheets
- Dimensional Data
- Wiring Schematics
- Field Connections

Note: The drawings included in this package are for controllers covered under our standard offering.
Actual AS BUILT drawings may differ from what is shown in this package.

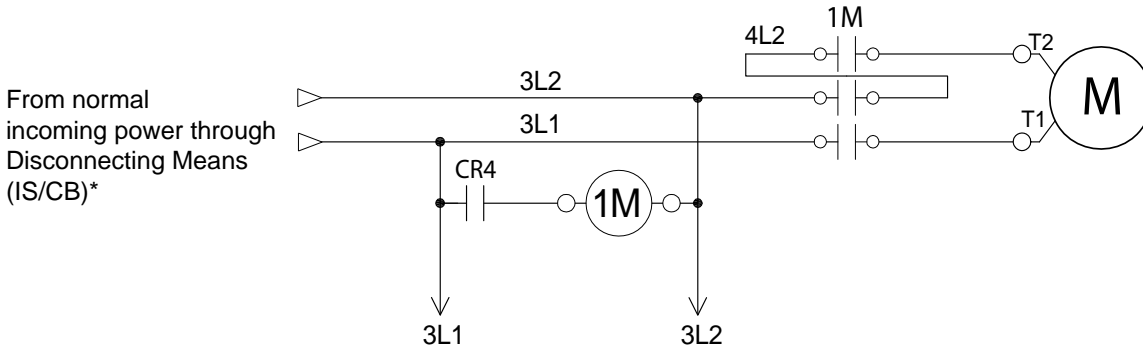

N.Y.C.
APPROVED

- Starting Method:** Full Voltage
Across the line (Direct on line)
- Typical Voltage Applied at Start:** 100%
- Inrush Current:** 6 x normal load current
- Starting Torque:** 100%
- Motor Type:** Across the line (Direct on line)
- No. of Contactors:** 1 at 100% of horsepower
- Min. ampacity of motor conductors:** 3 at 125% x 100% of Full load Current (FLC)

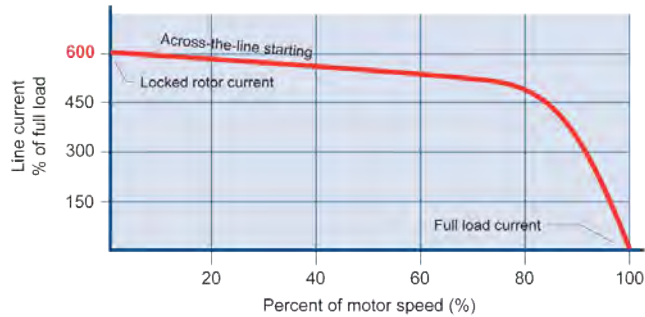

Shortcircuit Withstand Rating	208V to 240V- 1ph - 50/60Hz
Standard	65,000A
Optional	n/a

Standard, Listings, Approvals and Certifications	Built to NFPA 20 (latest edition)	
	Underwriters Laboratory (UL)	<ul style="list-style-type: none"> • UL218 - Fire Pump Controllers • UL 1008 - Automatic power transfer switches for fire pump controllers • CSA C22.2 No. 14 Industrial Control Equipment
	New York City	Accepted for use in the City of New York by the Department of Buildings
Enclosure	Protection Rating <input type="checkbox"/> Standard: NEMA 2 Optional <input type="checkbox"/> NEMA 12 <input type="checkbox"/> NEMA 4X-304 sst painted <input type="checkbox"/> NEMA 3 <input type="checkbox"/> NEMA 4X-304 sst brushed finish <input type="checkbox"/> NEMA 3R <input type="checkbox"/> NEMA 4X-316 sst painted <input type="checkbox"/> NEMA 4 <input type="checkbox"/> NEMA 4X-316 sst brushed finish	
	Accessories <ul style="list-style-type: none"> • Wall mounting lugs • Keylock handle 	Paint Specifications <ul style="list-style-type: none"> • Red RAL3002 • Powder coating • Glossy textured finish

*Please see Disconnecting Means details on page 3.



Technical Data Model GPL Electric Fire Pump Controller

Limitations	<ul style="list-style-type: none"> • Across the line starting only • Horsepower rating of maximum 30hp • Can only be installed where acceptable by the authority having jurisdiction • Not accepted in FM insured property
Surge Suppression	Surge arrestor rated to suppress surges above line voltage
Disconnecting Means	Circuit breaker (inverse time non adjustable) rated between 150% and 250% of motor full load current
Service Entrance Rating	Suitable as service entrance equipment
Emergency Start Handle	<ul style="list-style-type: none"> • Push and slide to lock • Across the line start (direct on line)
Electrical Readings	<ul style="list-style-type: none"> • Voltage phase to phase (normal power) • Amperage of each phase when motor is running
Pressure Readings	<ul style="list-style-type: none"> • Continuous system pressure display • Cut-in and Cut-out pressure settings
Pressure and Event recorder	<ul style="list-style-type: none"> • Pressure readings with date stamp • Event recording with date stamp • Under regular maintained operation, events can be stored in memory for up to 5 years. • Data viewable on operator interface display screen • Downloadable by USB port to external memory device
Pressure Sensing	<ul style="list-style-type: none"> • Pressure transducer for fresh water application • Pressure sensing connection 1/2" Female NPT • Rated for 0-500PSI working pressure (calibrated at 0-300psi) • Internally mounted



Technical Data Model GPL Electric Fire Pump Controller

Visual Indications & Alarms	<ul style="list-style-type: none"> • Power available • Phase reversal • Motor run • Pump room alarm • Motor trouble • Phase loss • Phase unbalance • Low water level 	<ul style="list-style-type: none"> • Locked rotor • Periodic test • Fail to start • Low discharge pressure • Low pump room temperature • Pump on demand/Automatic start • Emergency start • Manual start 	<ul style="list-style-type: none"> • Deluge valve start • Remote automatic start • Remote manual start • Overcurrent • Undercurrent • Undervoltage • Overvoltage
Remote Alarm Contacts	<p>SPDT-8A-250V.AC</p> <ul style="list-style-type: none"> • Power available • Phase reversal • Motor run • Common pump room alarm <ul style="list-style-type: none"> • Overvoltage • Low pump room temperature • Common motor trouble <ul style="list-style-type: none"> • Overcurrent • Undercurrent • Undervoltage • High Pump room temperature • Phase unbalance • Fail to start • Ground fault 		
ViZiTouch Operator Interface	<ul style="list-style-type: none"> • Embedded microcomputer with software PLC logic • 4.2" color touch screen (HMI technology) • Upgradable software • Expandable storage • Multi-language 		
Operation	Automatic Start	<ul style="list-style-type: none"> • Start on pressure drop • Remote start signal from automatic device 	
	Manual Start	<ul style="list-style-type: none"> • Start pushbutton • Run test pushbutton • Deluge valve start • Remote start from manual device 	
	Stopping	<ul style="list-style-type: none"> • Manual with Stop pushbutton • Automatic after expiration of minimum run timer ** 	
	Timers	Field Adjustable & Visual Countdown	<ul style="list-style-type: none"> • Minimum run timer **(off delay) • Sequential start timer (on delay) • Periodic test timer
	Actuation	Visual Indication	<ul style="list-style-type: none"> • Pressure • Non-pressure
	Mode		<ul style="list-style-type: none"> • Automatic • Non-automatic

**Can only be used if approved by the AHJ



Technical Data Model GPL Electric Fire Pump Controller

<input type="checkbox"/> A4	Flow switch provision
<input type="checkbox"/> A8	Foam pump application w/o pressure transducer and run test solenoid valve
<input type="checkbox"/> A9	Low zone pump control function
<input type="checkbox"/> A10	Medium zone pump control function
<input type="checkbox"/> A11	High zone pump control function
<input type="checkbox"/> A13	Non-pressure actuated controller w/o pressure transducer and run test solenoid valve
<input type="checkbox"/> A16	Lockout/interlock circuit from equipment installed inside the pump room
<input type="checkbox"/> B11	Built in alarm panel (120V.AC supervisory power) providing indication for: • Audible alarm & silence pushbutton for motor run, phase reversal, loss of phase. • Pilot lights for loss of phase & supervisory power available
<input type="checkbox"/> B11B	Built in alarm panel same as B11 but 220-240VAC supervisory power
<input type="checkbox"/> B19	High motor temperature thermistor relay c/w visual indication and alarm contact (Form C-SPDT)
<input type="checkbox"/> B21	Ground fault alarm detection c/w visual indication and alarm contact (Form C-SPDT)
<input type="checkbox"/> C1	Extra motor run alarm contact (Form C-SPDT)
<input type="checkbox"/> C4	Periodic test alarm contact (Form C-SPDT)
<input type="checkbox"/> C6	Low discharge pressure alarm contact (Form C-SPDT)
<input type="checkbox"/> C7	Low pump room temperature alarm contact (Form C-SPDT)
<input type="checkbox"/> C10	Low water reservoir level alarm contact (Form C-SPDT)
<input type="checkbox"/> C11	High electric motor temperature alarm contact (Form C-SPDT)
<input type="checkbox"/> C12	High electric motor vibration c/w visual indication and alarm contact (Form C-SPDT)
<input type="checkbox"/> C14	Pump on demand/automatic start alarm contact (Form C-SPDT)
<input type="checkbox"/> C15	Pump fail to start alarm contact (Form C-SPDT)
<input type="checkbox"/> C16	Control voltage healthy alarm contact (Form C-SPDT)
<input type="checkbox"/> C17	Flow meter valve loop open c/w visual indication and alarm contact (Form C-SPDT)
<input type="checkbox"/> C18	High water reservoir level c/w visual indication and alarm contact (Form C-SPDT)
<input type="checkbox"/> C19	Emergency start alarm contact (Form C-SPDT)
<input type="checkbox"/> C20	Manual start alarm contact (Form C-SPDT)
<input type="checkbox"/> C21	Deluge valve start alarm contact (Form C-SPDT)
<input type="checkbox"/> C22	Remote automatic start alarm contact (Form C-SPDT)
<input type="checkbox"/> C23	Remote manual start alarm contact (Form C-SPDT)
<input type="checkbox"/> C24	High pump room temperature alarm contact (Form C-SPDT)
<input type="checkbox"/> Cx	Additional visual and alarm contact (specify function) (Form C-SPDT)

<input type="checkbox"/> D1	Low suction pressure transducer for fresh water rated at 0-300PSI with visual indication and alarm contact
<input type="checkbox"/> D1A	Low suction pressure transducer for sea water rated at 0-300PSI with visual indication and alarm contact
<input type="checkbox"/> D10	Omit mounting feet (when applicable)
<input type="checkbox"/> D14	Anti-condensation heater & thermostat
<input type="checkbox"/> D14A	Anti-condensation heater & humidistat
<input type="checkbox"/> D14B	Anti-condensation heater & thermostat & humidistat
<input type="checkbox"/> D15	Tropicalization
<input type="checkbox"/> D18	CE Mark with factory certificate
<input type="checkbox"/> D26	Modbus RTU provision
<input type="checkbox"/> D26A	Modbus TCP/IP provision
<input type="checkbox"/> D27	Motor heater connection (external single phase power source and heater on/off contact)
<input type="checkbox"/> D27A	Motor heater connection (internal single phase power source and heater on/off contact)
<input type="checkbox"/> D28	Customized drawing set
<input type="checkbox"/> D34	Field programmable I/O board - 8 Input / 5 output
<input type="checkbox"/> D35	Field programmable I/O board - 8 Input / 10 output
<input type="checkbox"/> D36	Redundant pressure transducer for fresh water rated for 0-500PSI (calibrated at 0-300PSI)
<input type="checkbox"/> D36A	Redundant pressure transducer for sea water rated for 0-500PSI (calibrated at 0-300PSI)
<input type="checkbox"/> D37	Window kit for operator interface
<input type="checkbox"/> E1	Permanent load shedding contacts
<input type="checkbox"/> E2	Temporary pump motor start period load shedding contacts
<input type="checkbox"/> E3	Temporary & permanent load shedding contacts

Note: Options chosen from this page are not electrically represented on the wiring schematics in this submittal package.



Technical Data Model GPL Electric Fire Pump Controller

<input type="checkbox"/> L01	Other language and English (bilingual)
<input type="checkbox"/> L02	French
<input type="checkbox"/> L03	Spanish
<input type="checkbox"/> L04	German
<input type="checkbox"/> L05	Italian
<input type="checkbox"/> L06	Polish
<input type="checkbox"/> L07	Romanian
<input type="checkbox"/> L08	Hungarian
<input type="checkbox"/> L09	Slovak
<input type="checkbox"/> L10	Croatian

<input type="checkbox"/> L11	Czech
<input type="checkbox"/> L12	Portuguese
<input type="checkbox"/> L13	Dutch
<input type="checkbox"/> L14	Russian
<input type="checkbox"/> L15	Turkish
<input type="checkbox"/> L16	Swedish
<input type="checkbox"/> L17	Bulgarian
<input type="checkbox"/> L18	Thai
<input type="checkbox"/> L19	Indonesian
<input type="checkbox"/> L20	Slovenian

Note: Options chosen from this page are not electrically represented on the wiring schematics in this submittal package.

ViZiTouch Operator Interface

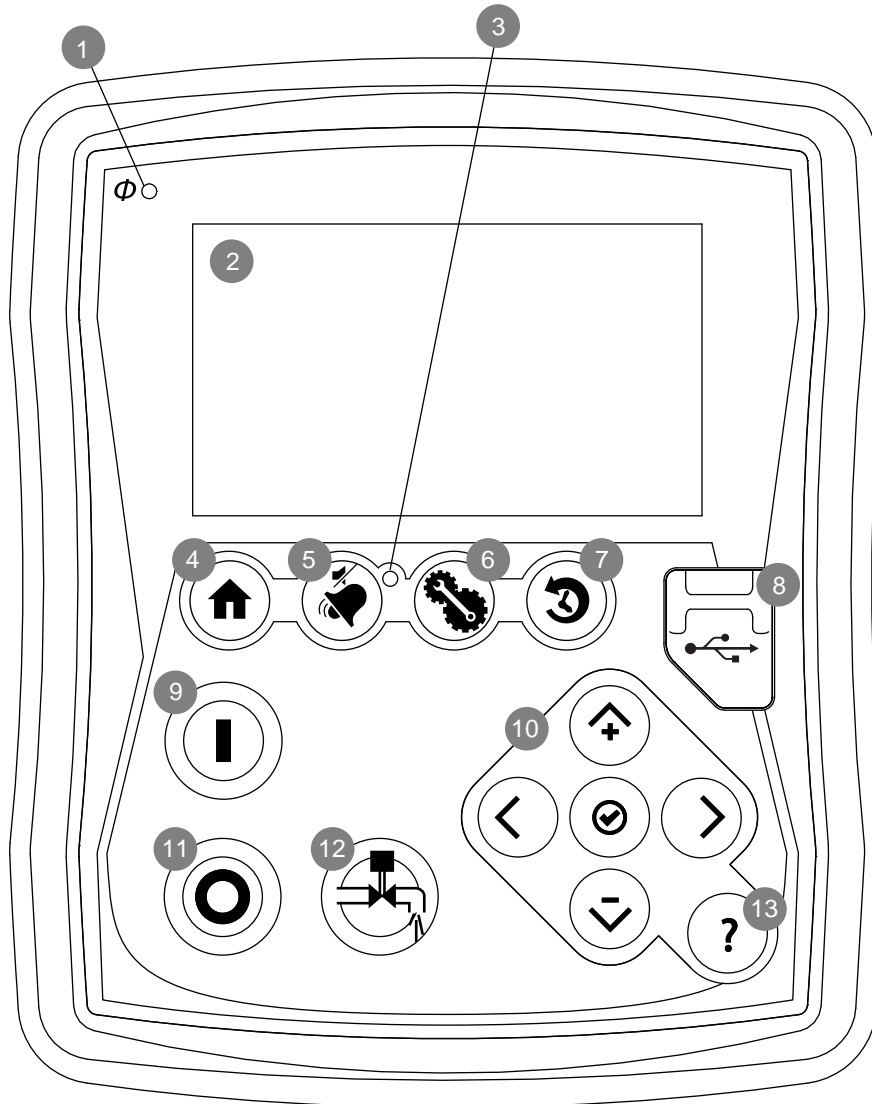

- | | |
|-------------------------------|--------------------------------|
| 1 - Power on LED | 8 - USB port |
| 2 - Color touch screen | 9 - START button |
| 3 - Alarm LED | 10 - Contextual navigation pad |
| 4 - HOME page button | 11 - STOP button |
| 5 - ALARM page button | 12 - RUN TEST button |
| 6 - CONFIGURATION page button | 13 - HELP button |
| 7 - HISTORY page button | |

LIMITED SERVICE PUMP CONTROLLER

MODEL : GPL

1 AND 3 PHASE

Dimensions

BUILT TO THE LATEST EDITION OF THE NFPA20 STANDARD

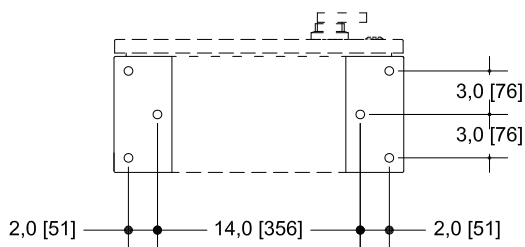
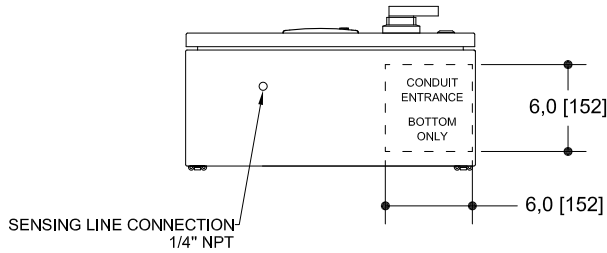
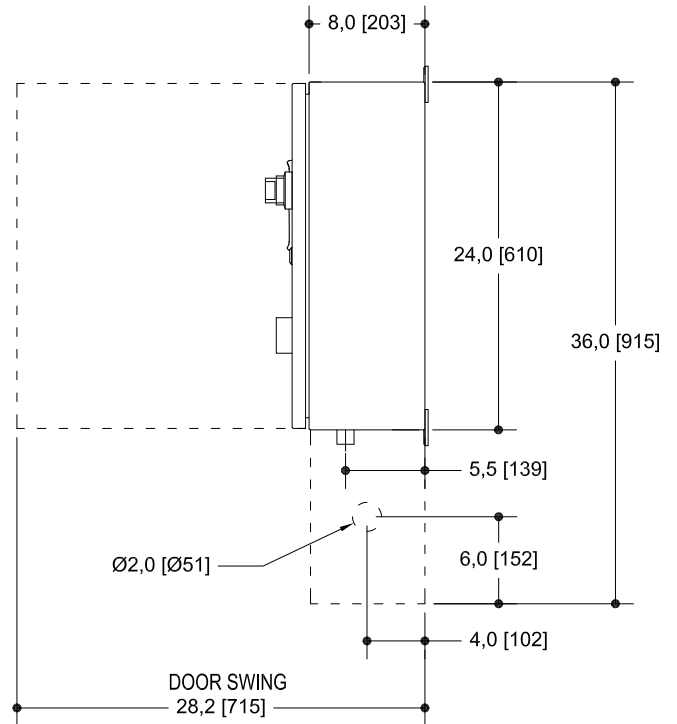
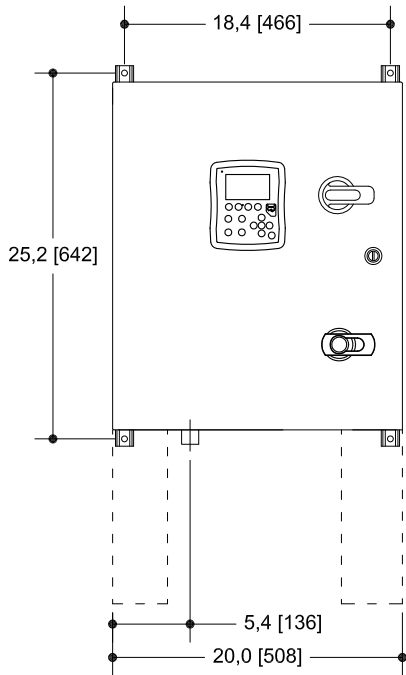

NOTES :

- ALL DIMENSIONS ARE IN INCHES (MILLIMETERS).
- PAINT : TEXTURED RED RAL 3002.
- USE WATERTIGHT CONDUIT CONNECTOR ONLY.
- PROTECT EQUIPMENT AGAINST DRILLING CHIPS.
- AMBIENT TEMPERATURE : BETWEEN 41°F (5°C) AND 104°F (40°C).

VOLT/Hz	HP RATING		WITHSTAND RATING [kA] RMS	
	MIN HP	MAX HP	STANDARD	HIGH (OPT. D13)
1 PHASE				
200-208 / 60	3 HP	15 HP	65kA	N/A
230-240 / 50-60	3 HP	15 HP	65kA	N/A
3 PHASES				
200-208 / 60	3 HP	30 HP	65kA	N/A
230-240 / 50-60	3 HP	30 HP	65kA	N/A
380-415 / 50-60	3 HP	30 HP	25kA	65kA
440-480 / 50-60	3 HP	30 HP	25kA	65kA
575-600 / 60	3 HP	30 HP	18kA	25kA

Drawing for information only.
 Manufacturer reserves the right to modify this drawing without notice.
 Contact manufacturer for "As Built" drawing.



REV.	DATE	DESCRIPTION	APP.
1.	12/08/06	GENEAREAL REVISION	DES.
0.	12/01/10	FIRST ISSUE	VER.

DRAWING No.

GPL-DI100 / E

LIMITED SERVICE PUMP CONTROLLER 1 PHASE

MODEL :GPL

Wiring schematic

BUILT TO THE LATEST EDITION OF THE NFPA20 STANDARD

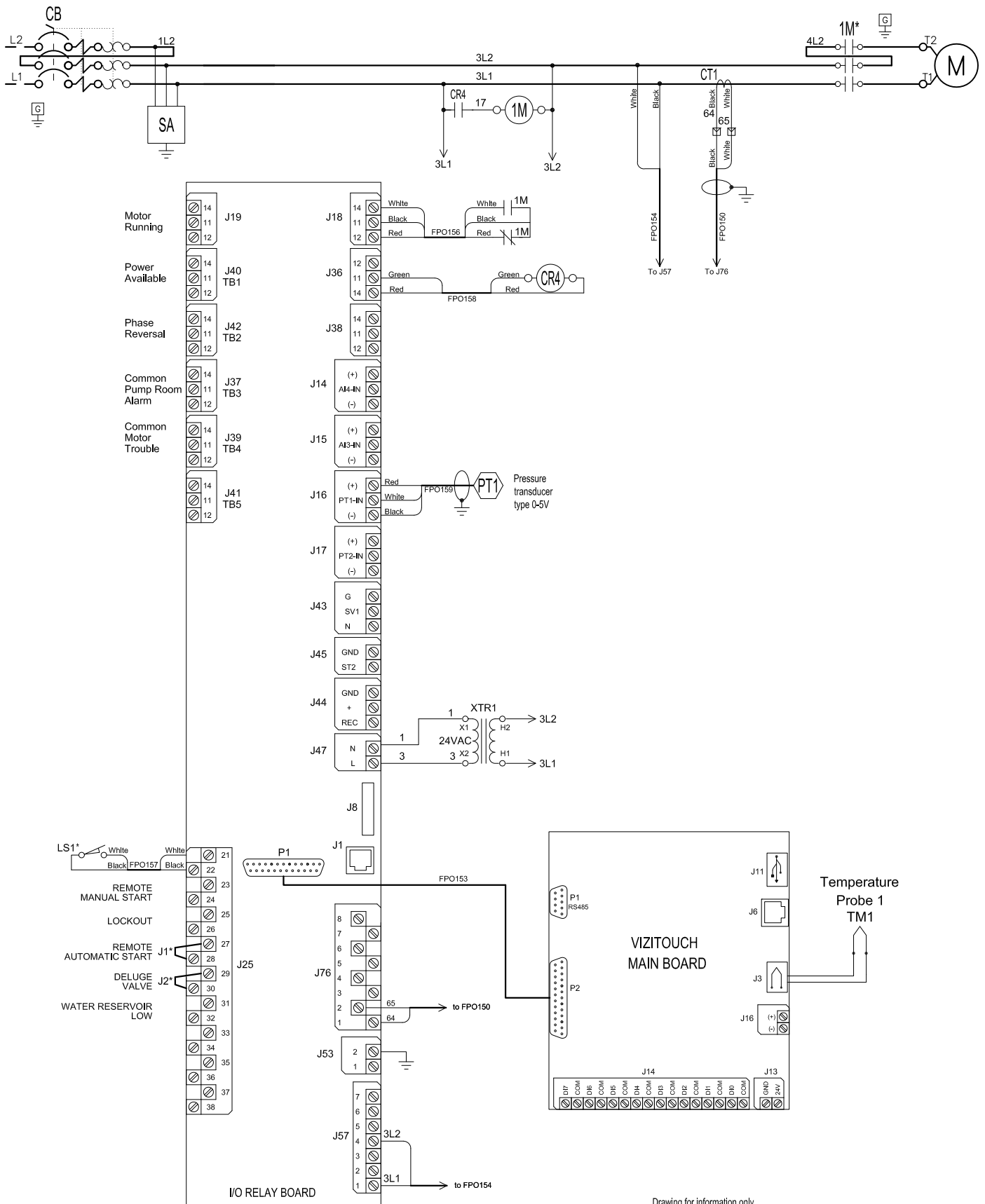

Drawing for information only.
Manufacturer reserves the right to modify this drawing without notice.
Contact manufacturer for "As Built" drawing.

* REMOVE JUMPER TO USE THIS FEATURE

* Contact closed when Emergency Start is in ON position

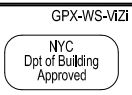

REV.	DATE	DESCRIPTION	APP.
3.	12/11/21	Correct Signal Input	DES.
2.	12/08/06	General Revision	VER.

Drawing No.
GPL-WS500 /E

Power Terminals
Model : GPL 1 PHASE

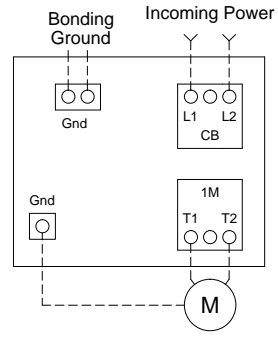

- Notes:
- 1 - For proper wire sizing, refer to NFPA70 and NEC (USA) or CEC (Canada) or local code.
 - 2 - Controller suitable for service entrance in USA.
 - 3 - For more accurate motor connections refer to motor manufacturer or motor nameplate.
 - 4 - Controller is phase sensitive.
 - 5 - Field wiring and lug sizes based on copper conductors only.
Do not use aluminium conductors.

Circuit breaker (CB) Field Wiring according to Bending Space (AWG or MCM). TERMINALS L1 - L2

Bending Space	3 " (76 mm)				
HP	3	5	7.5	10	15
Voltage					
208	1x (10 to 1)	1x (8 to 1)	1x (6 to 1)	1x (4 to 1)	1x (3 to 1)
220 to 240	1x (10 to 1)	1x (8 to 1)	1x (8 to 1)	1x (6 to 1)	1x (3 to 1)

(Use Copper Conductors Only)

Wiring Size for motor connection for Model GPL (AWG or MCM). TERMINALS T1 - T2

HP	3	5	7.5	10	15
Voltage					
208	1x (10 to 3)	1x (8 to 3)	1x (6 to 3)	1x (4 to 1)	1x (3 to 1)
220 to 240	1x (10 to 3)	1x (8 to 3)	1x (8 to 3)	1x (6 to 1)	1x (3 to 1)

(Use Copper Conductors Only)

Drawing for information only.
 Manufacturer reserves the right to modify this drawing without notice.
 For drawing for approval or installation, please contact manufacturer.



REV.	DESCRIPTION	DD/MM/YY	Drawing number
6	UPDATE WIRE SIZE	06/11/14	GPL-TD500 1/2 /E
5	FIELD PROG	11/11/13	
4	GENERAL REVISION	19/10/12	

Remote Alarm Terminals (I/O board)

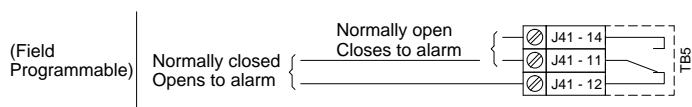
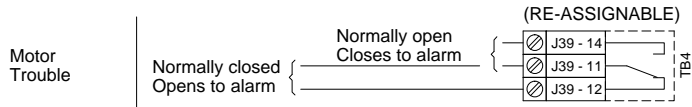
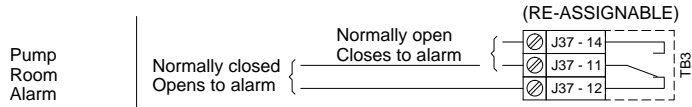
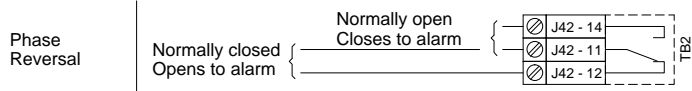
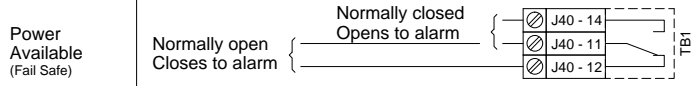
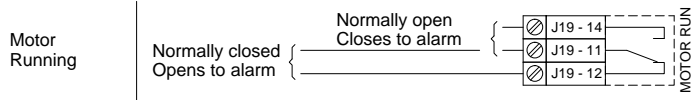

Control Terminals (I/O board)

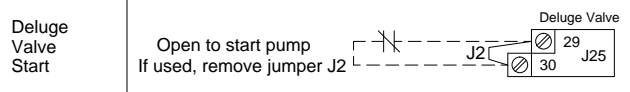
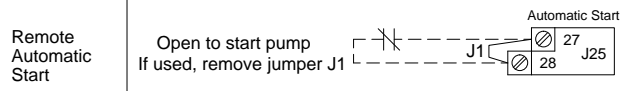
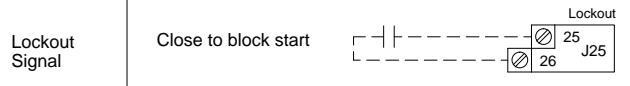
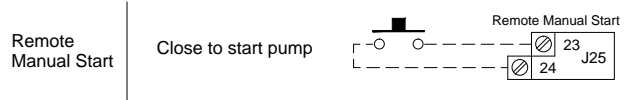

Field Connections for External Devices (I/O board)

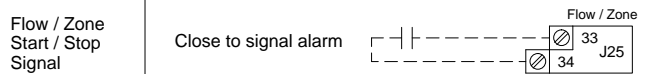
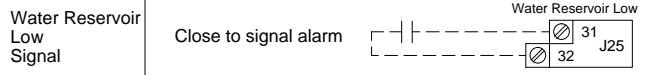

Drawing for information only.
 Manufacturer reserves the right to modify this drawing without notice.
 For drawing for approval or installation, please contact manufacturer.



REV.	DESCRIPTION	DD/MM/YY	Drawing number
6	UPDATE WIRE SIZE	06/11/14	GPL-TD500 2/2 /E
5	FIELD PROG	11/11/13	
4	GENERAL REVISION	19/10/12	